

ROZMĚRY PŘIPOJOVACÍCH OTVORŮ

M=1:10

KORAFLEX FV 8/28 A=50, B=50
KORAFLEX FV 9/28 A=50, B=80

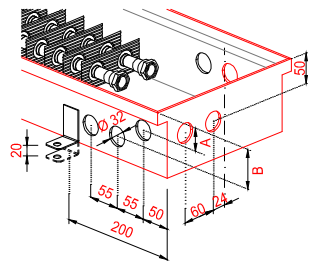

KORAFLEX FV
11/28 A=80, B=20, C=74, D=57
11/34 A=79, B=10, C=70, D=62
11/42 A=120, B=31, C=70, D=54

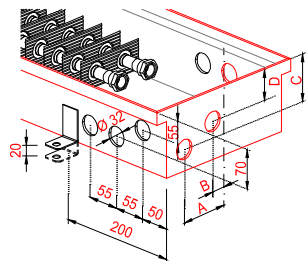

KORAFLEX FI 11/20
KORAFLEX FV 11/20

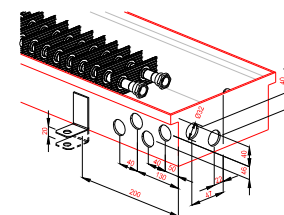

KORAFLEX FI 13/34

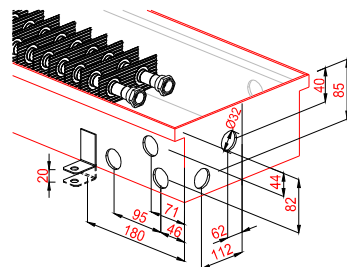

KORAFLEX FW 13/34

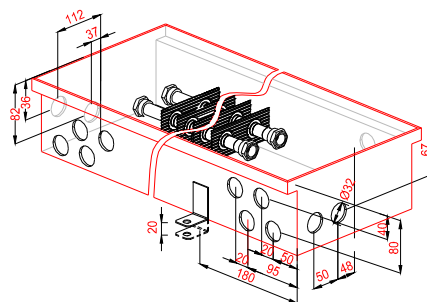

KORAFLEX FV 11/34 InPool

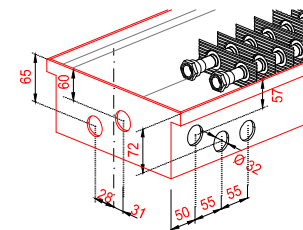

KORAFLEX FV 8/16

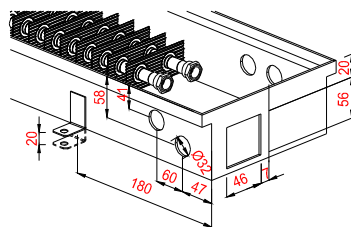

KORADO a.s.
Bří Hubálků 869
560 02 Česká Třebová
Czech Republic